

OPERATION AND MAINTENANCE MANUAL

Refrigerated counter BERILL BP

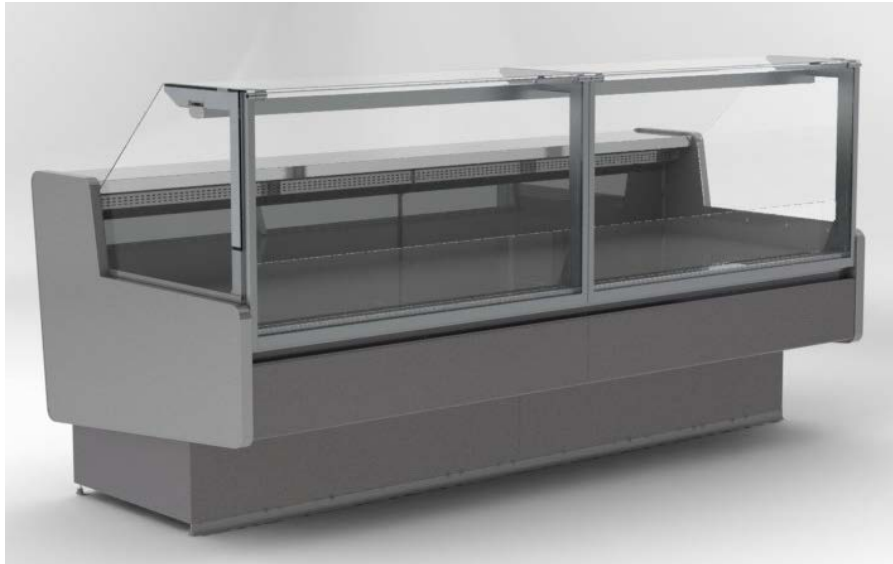

INTRODUCTION

The aim of the following guidelines is to inform a customer on how to operate, install, clean and maintain the equipment.

Read these guidelines carefully before running the equipment. Keep this document as a permanent source of information when operating the equipment and follow the corresponding instructions.

As a manufacturer, we are not responsible for any damage resulting from:

- Incorrect installation and/or operation;
- Making changes to the equipment without our written consent;
- Non-compliance with the established standards;
- Use of the equipment, inappropriate to its functional designation;
- Failure to follow the maintenance instructions;
- Use of non-original spare parts/accessories;
- Failure to follow the recommendations and instructions contained in this manual.

Notice:

All dimensions in drawings are given in mm, if not otherwise specified.

Illustrations may not fully correspond to the models shown in the guidelines.

CONTENTS

1. IMPORTANT NOTES.....	2
2. SAFETY MEASURES.....	3
3. GENERAL CHARACTERISTICS.....	4
4. INSTALLATION AND MOUNTING.....	6
5. OPERATION AND FOODSTUFF ALLOCATION.....	7
6. MAINTENANCE AND CLEANING	9
7. LIGHTING.....	10
8. ENERGY SAVING.....	11
9. TECHNICAL ISSUES AND SOLUTIONS.....	11
10. ENVIRONMENTAL PROTECTION.....	12
11. SPECIAL CONDITIONS.....	12
12. ELECTRIC WIRING DIAGRAM	13
13. WARRANTY FOR MATERIALS	14
CE DECLARATION OF CONFORMITY.....	15

1. IMPORTANT NOTES



1.1 UNPACKING AND TRANSPORTATION

Make sure the package is intact. If it shows signs of improper handling or damage during transportation, indicate this in the accompanying transport documents and immediately inform the supplier.

The device is delivered on a wooden pallet adapted for operation by a hand cart or lift. Use lifting devices that match the weight of the equipment.

All packaging materials are recyclable and must be disposed of in accordance with local standards.

Do not press the side glass panels to move the display cabinet. They can break and cause serious injuries.

1.2 INTENDED USE

This equipment is intended for storing and displaying food.

1.3 DEVELOPMENT AND STANDARDIZATION

This equipment has been designed and manufactured in accordance with the main requirements of the European Low Voltage Directive (LVD) 2014/35/EU and the EU Electromagnetic Compatibility Directive (EMC) 2014/30/EU, as well as in accordance with the provisions of the standard EN 60335-2-89 – Household electrical Appliances and their analogues – Safety – Special rules for refrigeration equipment intended for commercial use.

The equipment has been tested in accordance with the ISO 23953-2 standard-Display cases-refrigerators, and in accordance with the environmental conditions of climate class 3 (25 ° C-60%). When using the display case in an environment that has a different value from the above, the thermodynamic efficiency indicator may decrease and energy consumption may increase slightly.



2. SAFETY MEASURES



2. CHILD SAFETY

Children should be supervised and not allowed to play with the device. Keep all packaging materials, especially plastic ones, out of their reach.

2.2 GENERAL SAFETY RULES

This unit of furniture is intended for storing and displaying food.

This equipment was designed and manufactured in accordance with the requirements and environmental conditions of climate class 3 (25 ° C - 60%).



The equipment is not intended for use outdoors or in the rain.

When operating the equipment either separately or in groups, keep all air vents open.

Do not store explosive substances or objects, such as aerosol cans containing flammable mixtures, inside this appliance.



Do not remove ice that may have accumulated inside the equipment with a spatula, knives, or other metal objects.

Be careful not to damage the piping of the cooling circuit.

Do not use steam or running water to clean the equipment. Do not allow water to enter the equipment, especially not on the electrical components.



ATTENTION: it is strictly forbidden to turn on the display case without grounding and move the display case that is under voltage!

Make sure that both the supply voltage and the current corresponds to the parameters indicated on the nameplate.

Prior to performing cleaning or maintenance the display case must be disconnected from the electrical network.

If the equipment ignites, turn it off and use a fire extinguisher, but only the powder type. Do not use water to extinguish.

3. GENERAL CHARACTERISTICS

Technical data	Measurement unit	Typical size			
		125	187	250	375
Climate class		3 (25°C / 60%) Rh			
Useful volume temperature	°C	- 2 ...+6			
Display depth	mm	800			
Display area	m ²	1,0	1,5	2,0	3,0
Volume of internal space	m ³	0,81	1,21	1,61	2,42
Usable shelf space / cooling storage	m ³	190 /105	285 /160	380 /215	570 /320
Electric data					
Power supply	V/Hz	230 – 50 – 1			
Electrical equipment protection rate	code	IP 20			
Rated electricity input in refrigerating mode	W	55	85	100	145
Rated electricity input in defrosting mode	W	245	275	390	535
Rated power consumption per day* ¹	kW*h	1,46	2,05	2,56	3,65
Basic set of the cabinet (light-12h)					
Basic set of the cabinet (light-24h)		1,64	2,34	2,92	4,19
Cooling data					
Refrigerant	type	R404A			
Defrosting		Automatic			
Rated cooling capacity input * ² (at boiling temperature minus 10°C)	W	400	590	790	1200
Dimensions					
<u>Overall dimensions:</u>					
length without side walls	mm	1250	1875	2500	3750
length with side walls		1330	1955	2580	3830
width without side walls		1090	1090	1090	1090
width with side walls		1120	1120	1120	1120
height without side walls		1180	1180	1180	1180
height with side walls		1180	1180	1180	1180
Weight (without shelves and side walls / with side walls)	kg	145 / 175	200 / 230	260 / 290	370 / 400
*1 - four defrosting procedures a day					
*2 - with a constant surrounding temperature of t 25°C and a relative humidity 60%.					

3.1 SECTIONS AND PLANS

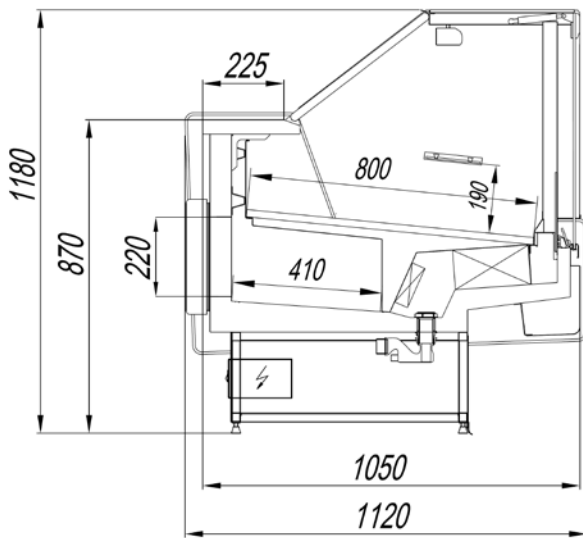

Maximal load
 Basic shelf 50 kg / m²
 Upper shelf 5 kg

3.2 FACTORY SETTINGS

Table of key controller parameters (Eliwell ID 983 LX)

#	Specification	Programmed
Set	Setpoint	+1,2 °C
diF	differential	2 °C
dty	defrost type	0
dit	defrost interval time	6 hours
dEt	defrost endurance time	40 min
dSt	defrost stop temperature	+8 °C
ndt	number display type	y
H00	selection of probe type, (1=NTC)	1
H21	digital output configurability (B) (1=compressor)	1
H22	digital output configurability (A) (2=defrost)	2

4. INSTALLATION AND MOUNTING

This type of equipment should be installed and mounted by qualified and experienced technicians.

4.1 IMPORTANT SAFETY INSTRUCTIONS

Please, follow these instructions while installing the cabinet:

- Personnel responsible for moving and installing equipment must have flexible and non-slip work gloves, safety glasses, and safety shoes that must be used whenever necessary.

- Follow the instructions in the "Installation" section of the current manual and additional guidelines, if applicable.

- Do not walk on the equipment.

- Do not install and use the equipment if it is damaged.

At installing the device near a wall, respect the distance of not less than 60 mm.

ATTENTION! Do not block the air vents located in the device body;

Do not install the equipment:

- Under direct sunlight;

- Near heat sources such as batteries, heaters, or stoves;

- Near ventilation grilles, doors, windows, and air conditioning outlets where the air flow velocity exceeds 0.2 m/s.

4.2 POWER SUPPLY CONNECTION

Make sure the voltage of the electric supply corresponds to the data specified on the nameplate of the device. Deviations in the electric supply circuit voltage should not exceed $\pm 10\%$ from those specified on the nameplate.

The equipment does not have any protection from overvoltage, so it is recommended to check the safety level of the electric circuit to which the device will be connected to.

The device has a terminal for connecting with a potential equalization connector when it is necessary to prevent the presence of voltage when touching between the grounding equipment and metal parts that may accidentally come into contact with current-carrying electrical wires. This terminal, marked with the corresponding symbol, is located in the electronics unit and is intended for connection to the ground circuit with a wire with a cross section of 2.5-6 mm².



4.3 EQUIPMENT MOUNTING

Thoroughly remove any polyethylene film protecting the components and parts of the display cabinet.

If this manual contains a Chapter with installation Instructions, follow the sequence indicated for proper installation.



Align the display case in a horizontal position by adjusting the leveling feet to ensure:

- Proper operation;
- Smooth operation of water supply and water removal after defrosting the evaporator;
- Noise reduction from the vibration of working parts.

Use only hand tools to fix screws when mounting glass components and parts.

We recommend installing, if necessary, mechanical protection devices adapted to the equipment to prevent possible damage, for example, from the impact of a trolley, a polisher, a loader, etc.

At the end of installation clean the display cabinet as described in point 6.1.

5. OPERATION AND FOODSTUFF ALLOCATION

The display case should only be switched on after preparation for use, which must be carried out by qualified certified personnel

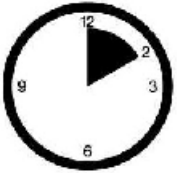

After turning on the device wait at least 2 hours before loading the products.

For devices equipped with an electronic temperature controller, follow the specific instructions of the manual provided with the display case. The controller has factory settings. Their changes should only be carried out by a qualified specialist.

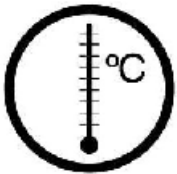

It is important to note that this equipment is not intended to lower the temperature of products, but only to maintain the temperature at which they are stored (in accordance with the temperature class of the equipment).

Follow the storage instructions on the food packaging. Food products with a higher storage temperature than that of the display case should not be stored in it.

Do not leave cooled food products in boxes or pallets for longer than the time necessary for unloading / loading of the equipment.

Food products should be placed in such a way that no voids are formed and an even distribution of cold air is ensured. Make sure that when you load the products, they do not block the access of the cooled air (air intake vent).



Respect loading limit indicated () directly on the equipment or sticker at the side-wall glass. Do not exceed limiting marks, since this may result in cooled air distribution disorder and consequently in false exploitation, damage to loaded products.

Never exceed the maximum permissible load for each shelf specified in this manual

To optimize the operation of the equipment and keep the food in good condition, use only the add-ons and accessories supplied with the display case.



ATTENTION! Do not use electrical appliances inside product storage compartments unless they are of the type recommended by the manufacturer.

In case the equipment has glass shutters (optional), they should be opened and closed carefully.



Do not use the roof of the display cabinet to store packing, spare parts and other materials.

5.1. TEMPERATURE CONTROL AND REGULATION

If the equipment is not connected to a central monitoring system with an alarm, you should check the temperature value displayed on the controller screen several times a day, or at regular intervals, in accordance with local regulations.

The signals will be visible on the screen, depending on the type of equipment, model, or version of the controller. Their description can be found in the operations manual for the controller.

On devices equipped with an electronic temperature controller, follow the specific instructions provided with the display case.

As a reminder, the controller has factory settings and their changes must be carried out by a qualified specialist.

6. MAINTENANCE AND CLEANING



Before cleaning disconnect power supply of the display case.

Maintenance and care of the display cabinet encourage sales, but most importantly it is a safety measure to protect food products from microorganisms and bacteria and therefore the customers' health.

During their loaded use the display cabinets must be clean and free from garbage, labels, packages or dust both in the exterior and the interior parts, including those which are accessible only after removing the grids and trays. Improper maintenance can lead to faults. These include, but are not limited to, air ventilation blockage and the contamination of the drainage pipeline, which can result to the flooding and malfunction of electric components. Improper functioning of the electric components will reflect on the functioning of the cooling system and will lead to expensive repair and operational downtime of the equipment.

Good care and proper cleaning will establish a positive image of the seller.

6.1 CLEANING



Before cleaning or maintenance the equipment must be disconnected from the power supply to guarantee the absence of an electric current in the system.

We recommend performing cleaning in compliance with the following table:

	Packaged goods	Goods without packing
Display surface	Weekly	Daily
grids/air conduits	Monthly	Daily
Panels, in depth	Monthly	Weekly
Containers	Monthly	Weekly
Drainage holes	Monthly	Weekly

Do not use abrasive materials and substances or solvents, salt acids, detergents with chlorine or pure spirit. Do not use metal or abrasive swabs for cleaning in order not to damage the appearance and ensure a long service life of the equipment.



ATTENTION! Do not use mechanical devices or other means to enforce defrosting, except for the ones recommended by the manufacturer;

Clean the interior and exterior surfaces regularly with soft cloth, dampened with warm water and a neutral chlorine-free detergent. Dry all water residues thoroughly using a sponge. To clean the glass parts, use an appropriate liquid cleaner.



When washing the floors near the equipment, try to avoid accidental splashes onto the cabinet – the chemical substances used for washing floors may fall on the equipment's components.

It is of utmost importance that the drainage pipeline remains clear to ensure the free movement of condensed water through the drainage hole.

In case the interior surface of the display cabinet is dirty and/or dusty due to packing damage, dirt, dust and other debris must be removed immediately, taking special care of components responsible for defrosting and condensed water drainage. Make sure that the drainage pipeline is not clogged or otherwise blocked.

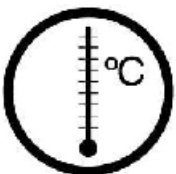

Notice: after cleaning foodstuffs must be loaded into the display cabinet only once the inside temperature reaches the defined values.



6.2 REGULAR MAINTENANCE

Before cleaning or maintenance the equipment must be disconnected from the power supply to guarantee the absence of an electric current in the system. Afterwards all products must be unloaded and stored in a cooling room.

Equipment, including those with an automatic defrosting controller, must be disconnected from power supply and cleaned (see chapter "Cleaning") at least once a month. Ice buildup in the evaporator reduces productivity and increases energy consumption.

ATTENTION: DO NOT USE MECHANICAL MATERIALS AT HAND TO ENFORCE EQUIPMENT DEFROSTING.



Never remove ice with the help of a spatula, knife or other metal tools. Ideally the evaporator should defrost on its own.

In case of heavy ice buildup on the evaporator, complete defrosting will take additional time. Due to a significant temperature differences during coolant evaporation or defrosting, please wait several minutes before exposing the zone near the evaporator to cleaning.

7. LIGHTING



7.1 LIGHTING / LAMPS REPLACEMENT.

When replacing lamps, disconnect the equipment from the power supply.

Any changes done to the electric grid must be performed only by an electrical engineer specialist.

In the case that this warning is violated, the company is not responsible of any damages incurred.

Please recycle used lamps in accordance to local regulations.

8. ENERGY SAVING

Possible actions for energy saving:

- Adjust the temperature levels in accordance with the food products typology;
- Make sure that packing, labels, advertising materials and the products themselves are not blocking the air circulation grid (both internal and external);
- Avoid an airflow directed towards the display cabinet, as well as heat-generating equipment in the vicinity of the display cabinet;
- Follow the specified loading limits.

9. TECHNICAL ISSUES AND SOLUTIONS

Prior to seeking maintenance service, perform the following actions in accordance with the problem observed:

1 – The equipment does not operate

- Check voltage supply;
- Make sure that automatic defrosting is not currently performed;
- Make sure that the main switch, if applicable, is in “I” position;
- Make sure that operational values are set to the appropriate levels, perform a regulation in compliance with the controller’s exploitation guidelines.

2 – Internal volume temperature is not low enough

- Make sure that temperature and air humidity values do not exceed 25°C / 60%;
- Check whether the equipment is not situated close to a heat source;
- Make sure that there are no draughts;
- Make sure that ice does not accumulate in excess in the evaporator, otherwise defrost the equipment manually (if it is not enough, disconnect the equipment for 24 hours);
- Food product’s temperature at loading was higher than the display cabinet designated operating temperatures;
- Make sure that the temperature is correctly adjusted on the controller;
- Make sure that packing, labels, advertising materials and the products themselves do not block the air circulation grid;
- Make sure that all components (ventilators, controllers, etc.) are connected and operating.

3 – The equipment makes much noise

- Make sure that the mobile working parts are not obstructed or in contact with other parts;
- Make sure that the equipment is placed properly on a level surface;
- Make sure that all elements are smoothly adjusted / fixed tightly.

4 – Ice overstock on the evaporator

- Make sure that the equipment doors are firmly closed;
- Check whether the doors are being opened for longer than required;
- Make sure that the display cabinet is not loaded with food products past a specified level;
- The automatic defrosting regime is underperforming. Perform defrosting manually in compliance with the guidelines in the user manual and follow the instructions in chapter 6.2 “Periodic Maintenance”.

5 – Glass is fogging from exterior

- High air humidity in a particular day;
- Very low temperature inside the equipment - adjust temperature up to a higher value;
- Interior air channel (if applicable) is blocked with products;
- Check whether the display cabinet is situated near the entrance door (place close to a high temperature difference).

In case the corresponding actions are not effective, apply to a local representative for the equipment’s maintenance.

The series number can be found on the equipment label, in the characteristics table.

10. ENVIRONMENTAL PROTECTION

This equipment does not contain chlorofluorocarbons (CFC).

10.1 UNPACKING

All packing materials are recyclable and should be disposed of in compliance with local regulations.

10.2 END OF THE EQUIPMENT'S LIFE-CYCLE

At the end of a useful life of the equipment, we recommend the following:

- Make it unserviceable (for example, cut power cable)
- Remove doors or other elements which may be dangerous for children or pets;
- Do not destroy the display cabinet or cooling system structure.

The European Directive 2002/96/EC (WEEE) extends to this equipment, and it cannot be sent to a municipal waste deposit and consequently must be delivered to a specialized point for electric and digital equipment wastes collection to perform accurate recycling.

11. SPECIFIC CONDITIONS

Information in these guidelines is valid at the moment of printing. Nevertheless, under the conditions of constantly developing technologies and product evolution, we reserve the right to change technical characteristics and content of this document.

We are not responsible for alterations introduced by a consumer towards the equipment and non-compliance with the recommendations and operating principles contained in this manual.

12. ELECTRIC WIRING DIAGRAM

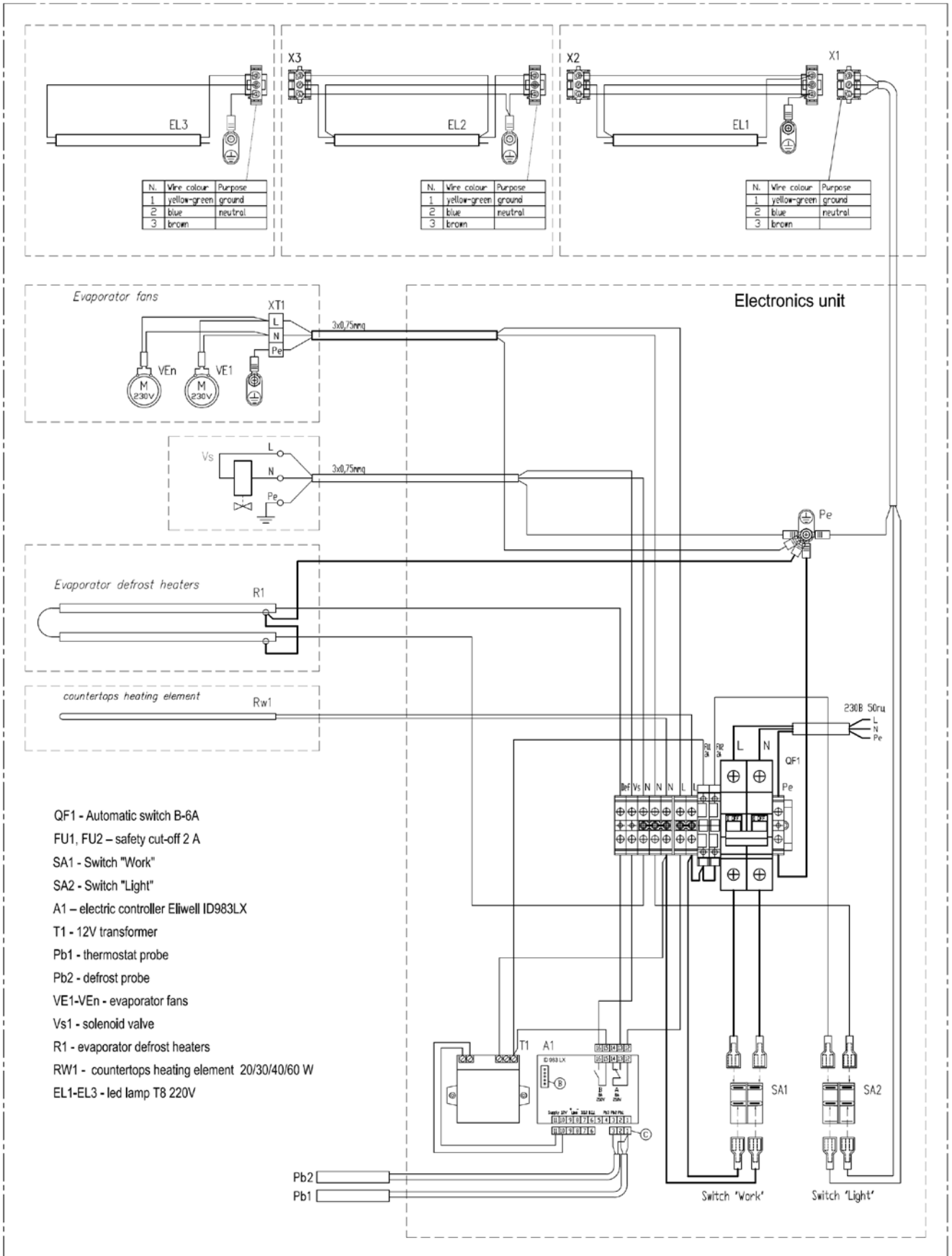

13. WARRANTY FOR MATERIALS

The components and parts of the display cabinet are covered by a 2-year warranty, starting from the date of issue of the display cabinet, which is indicated on the nameplate.

The warranty does not cover consumable parts (lamps, starters for fluorescent lamps etc.).

Warranty service expires in the event of damage to the display cabinet due to improper use, violation of safety rules or loss of the nameplate.

ДЕКЛАРАЦИЯ СООТВЕТСТВИЯ ЕС
EC Declaration of Conformity

Мы заявляем под нашу исключительную ответственность, что продукт:

We hereby certify under our exclusive responsibility that this product:

Витрина холодильная **БЕРИЛЛ БП**

BERILL BP *refrigerated counter for commercial use*

к которому относится настоящая декларация, соответствует следующему стандарту:

to which this declaration refer, is in conformity with the following standard:

EN 60 335-2-89 - бытовые и аналогичные электрические приборы - безопасность.

Часть 2 - 89: частные требования для коммерческого холодильного оборудования со встроенным или дистанционным узлом конденсации хладагента или компрессором

EN 60 335-2-89 - *Household and similar electrical appliances - Safety.*

Part 2 - 89: Particular requirements for commercial refrigerating appliances with an incorporated or remote refrigerant condensing unit of compressor.

в соответствии с директивами:

is in conformity with the Directives:

2014/30/EU (*Electromagnetic Compatibility*)

2014/35/EU (*Low Voltage*)

Kostroma, 2018-05-28

Avsiévitch V. A.

Generaldirektor

Note

The contents of this document are subject to change without notice